

# Temperonic 4 Zone Natural Ventilation Control Operators Manual



30-Nov-2020

Version S

## Controller Features:

- Controls 4 Curtain Actuators (10 Amp, 115/230V, 1/2HP)
- Controls 2 Heaters (20 Amp, 115/230V) if only 3 Actuators are used.
- Supports 4 Probes
- Select Probes to use for Curtains and Heaters
- Curtain Timers Accurate to 1 Second
- Different Temperatures can be set for Each Zone
- Heater Run Timers Record How Long Heaters Run
- Automatic Curtain Timer Adjustment for Sudden Temperature Changes
- Manual Curtain Movement with Latching
- High and Low Temperature Records
- 4 Digit Display
- User Friendly Setting Adjustments
- Indicators for Curtain and Heater Activity
- High and Low Alarm Settings
- Alarm Relay to Trigger Auto Dialer or Alarm System
- Wind Sensor Option to Close Curtain when Windy
- Option for Separate Rain Sensor Input

# Table of Contents.

Controller Features .....	1
Display Mode .....	4
Standard Settings .....	7
Hidden Settings .....	11
Wiring Diagrams .....	16
Warranty .....	20



# Controller Features

4 Digit  
Temperature  
Display.

4 Zone Natural  
Ventilation Control



ADJUST



Status Indicators show  
when actuators are moving  
or heaters are on.



SELECT

Mode



Open

Close

Curtain 1

Open

Close

Curtain 2

Open

Close

Curtain 3

Open

Close

Curtain 4

Heat Zone 1

Heat Zone 2

5 Buttons used to easily  
modify and save  
parameters. Use the  
buttons to scroll through  
display information.



Model: NV4C2H

# Control Operation



Under normal operating conditions, the control will show the average room temperature on the red LED display. Any Alarm codes will flash on the display.



The  button can be used to change from display mode to settings mode or even hidden settings mode.

The  and  buttons will scroll through the various display mode values. The  and  buttons will display additional information.

## Factory Settings

At times, it may be necessary to completely reset a control to the factory settings. This is accomplished by holding down the 3 buttons ,  and  as the power is turned on to the control.

The buttons must be held down until the display shows the room temperature.

## Alarms

When the control encounters an alarm condition, an alarm code will flash on the LED display. The Alarm Output indicator will also flash. If an external alarm is connected, it will be activated (for any alarms other than Power Failure Reset). When the alarm condition has been cleared, the  button will reset the alarm.

The LED Display will normally show the average room temperature. In the event of an alarm condition, the LED display will flash alarm codes 4 times. The following codes may appear.

<i>LED Display</i>	<i>Alarm Description</i>
H 1 1	High temperature Probe 1 (Change Parameter AL.HI to reduce the chance of a high temp. alarm)
H 1 2	High temperature Probe 2
H 1 3	High temperature Probe 3
H 1 4	High temperature Probe 4
LO 1	Low temperature Probe 1 (Change Parameter AL.LO to reduce the chance of a low temp. alarm)
LO 2	Low temperature Probe 2
LO 3	Low temperature Probe 3
LO 4	Low temperature Probe 4
PS 1 - PS 4	Probe has shorted. This appears when the wires to a particular probe have shorted.
noPb	No valid probes are connected.
PF	Power Failure Reset. This appears after the controller has reset – usually due to a power failure.

When alarms have occurred, be sure you **do not press** the  button since this will clear all alarms. Once all the alarm codes have been noted, the mode button may be pressed to clear the alarms. The alarm condition must have been corrected in order to clear the alarm code. For High and Low temperature Alarms, change AL.HI and AL.LO at the end of the Standard Settings.

# Display Mode:

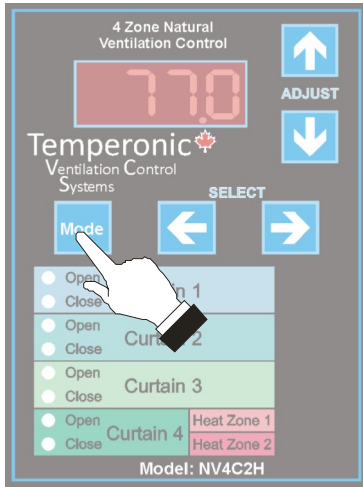

To return to the default display mode:

Press the **Mode** Button. If the display flashes **SEt.!** then press the mode button again. The display will then show the average temperature of the connected sensors.

NOTE: Control will automatically return to the default display mode 2 minutes after the last button press.

From the default display mode, use the select arrows **←** and **→** to display various values. These values are described in the following sections.

## **H 1°** High Temperature

This display Parameter shows the highest average temperature. Press both the **▲** and **▼** arrow at the same time to reset all high and low readings.

## **L 0° !** Low Temperature

This display Parameter shows the lowest average temperature since reset.

## **P-r-b 1 !** Probe 1 Temperature

This display Parameter shows the temperature at probe 1. The following Parameters show the other individual probe readings.

## **P-r-b2** Probe 2 Temperature

## **P-r-b3** Probe 3 Temperature

## **P-r-b4** Probe 4 Temperature



## Act Manually Move All Actuators.

Press the Up Arrow  
To move both curtains  
Closed. Press the  
Down Arrow to move  
both curtains Open.  
If the direction button is  
held for 8 seconds or more  
the curtain movement will  
'latch'. To indicate this, the  
display will change from  
horizontal lines  
to horizontal lines  
with sides  
when latched.

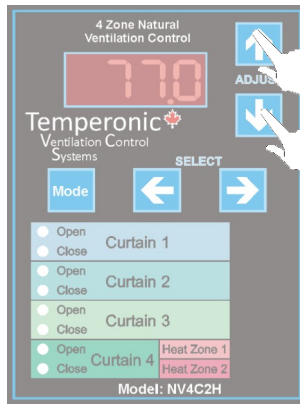

Up to  
Close

Down to  
Open

Curtains will stay latched until the Mode button is pressed (or the opposite direction is chosen). Note that latched curtain actuators will NOT operate automatically. To return to display room temperature while latched, the Select Arrows must be used to return to the default display Parameter. When a curtain is latched, the Open or Close indicator will flash.

## Wind Sensor Status:

If Wind Sensor Operation has been enabled (see the wind sensor settings in the hidden settings) then this Parameter will indicate if the wind sensor is detecting wind, if the curtain is closing due to wind and if the open delay timer is active.

Upper segment lights up to indicate curtain is closing due to wind sensor

Lower segment indicates curtain will not open due to open delay timer



Upper left segment of the first digit indicates rain sensor detects rain.

Decimal Point lights up when wind sensor flap moves toward the sensor

## Act 1 Act 2 Act 3 Act 4

## Manually Move Individual Actuators

Press the Up Arrow to close the actuator for the zone. Press the Down Arrow to open the actuator for the Zone. Individual actuators will latch if the direction arrow is held for more than 8 seconds (See Above)

## Run Time

This Parameter displays the number of minutes since the last run time reset. This parameter is to be used in combination with the next 2 parameters allowing the operator to determine exactly how much the heaters are running. The maximum value is 9999 minutes (just over an hour short of a full week). When 9999 is reached all 3 timers stop counting.



## **Hrt 1 Hrt2** Heater 1 and 2 Run Times



These parameters show how many minutes the heaters were running. run.t will show the total time since the last reset and Hrt1 will show how many minutes heater 1 was running during that time. Hrt2 is the same but it shows heater 2 run time.

# Standard Settings:

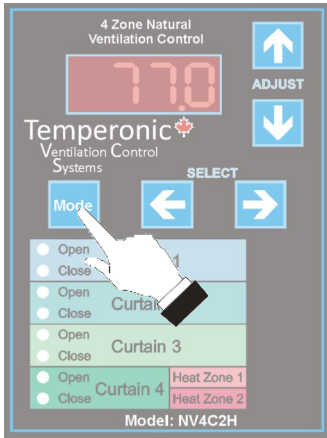
To view or modify Standard Settings,



Press the **Mode** Button. If the display flashes **SEtP** then you are in the Standard Settings Mode. You may need to press the **Mode** Button a second time to get **SEtP** to appear on the display.

The  arrow will increase Parameter values. The  arrow will decrease Parameter values.

NOTE: Control will automatically return to the default display mode 2 minutes after the last button press.

Use the select arrows  and  to choose various parameters.

## **SEtP** Set Point Zone 1

This parameter is the reference temperature for zone 1. The curtain will open and close based on this temperature. The heater will also turn on and off relative to this temperature.

*If the security setting is on (Hidden Parameter SECU), it will not be possible to adjust anything other than settings SEt.1 and SEt.2.*

## **OFS.1** Curtain 1 Temperature Offset

In certain cases, it may be necessary for one curtain actuator to work from a slightly different reference temperature than the Set Point. The OFS.1 parameter allows the user to specify a temperature offset. If the offset is set at 3.0°, then the centre of the deadband will be found at the Set Point + 3.0° and the curtain won't begin opening till the room is warmer by 3.0°. If it is set at -3.0° then the curtain will begin opening at a temperature 3.0° cooler than if this parameter was left at 0.

## **db.1** Curtain Dead Band Zone 1

This parameter defines the dead band for Zone 1. This is the temperature above and below the set point where the curtain will remain where it is. The dead band is centred on the set point. A dead band of 3.6° will not move the curtain unless the temperature climbs 1.8° above the set point or drops 1.8° below the set point.

## **OPn.1** Curtain Open On-Time Zone 1

When the temperature is high enough and the curtains are to open, the actuator will open for the amount of time specified in this setting. Then the curtain will stop and remain in place for the "Off Time" below. There are 3 settings in the

hidden settings that will automatically adjust the timers for a longer on-time if the room temperature is very far from the target temperature.

### **CLo.1 Curtain Close On-Time Zone 1**

When the room temperature is cool enough, the curtains will begin to close. The curtain will run for the amount of time specified in this setting then it will stop and remain in place for the “off” time (see next parameter).

### **OFF.1 Curtain Zone 1 Off Time**

After the curtain moves open or closed for the time specified, the curtain will stop for the time specified here. This allows time for the room temperature to adjust.

The next 5 settings are very similar to Zone 1 but apply to Curtain Zone 2 through 4

OF5.2 db.2 OPn.2 CLo.2 OFF.2

OF5.3 db.3 OPn.3 CLo.3 OFF.3

OF5.4 db.4 OPn.4 CLo.4 OFF.4

### **HEA.1 Heater Turn-On Temperature Zone 1**

This parameter defines the turn-on point for the heater. It is important to set this value a few degrees lower than the point at which the curtain begins closing since the heater should only operate when the curtain is closed. Typically, this value will be a negative value that is greater than half of the dead band value.

### **HEA.2 Heater Turn-On Temperature Zone 2**

This parameter defines the turn-on point for the heater. It is important to set this value a few degrees lower than the point at which the curtain begins closing since the heater should only operate when the curtain is closed. Typically, this value will be a negative value that is greater than half of the dead band value.

### **ALH.1 High Temperature Alarm Setting**

This parameter defines the high temperature alarm setting. This parameter specifies a value relative to the set point. If any of the probes exceed a temperature of the Set Point + this parameter, a high temperature alarm will be issued for the probe.

### **ALLO Low Temperature Alarm Setting**

This parameter defines the low temperature alarm setting. This parameter specifies a value relative to the set point. If any of the probes drop below the temperature of the Set Point + this parameter, a low temperature alarm will be issued for the probe.

<b>Setting</b>	<b>Units</b>	<b>Factory Default</b>	<b>Range</b>	<b>Record Your Settings</b>
SEtP Set Point	°F °C	77.0 25.0	-40 to 99 -40 to 37.2	
OF5.1 Offset Temp. Zone 1	°F °C	0.0 0.0	-36 to 36 -20 to 20	
db.1 Dead Band Zone 1	°F °C	3.6 2.0	0 to 36 0 to 20	
OPn.1 Curtain Open On-Time	Seconds	3	0 to 254	
CLo.1 Curtain Close On-Time	Seconds	5	0 to 254	
OFF.1 Curtain Off Time	Seconds	140	0 to 254	
OF52 Set Point Zone 2	°F °C	0.0 0.0	-36 to 36 -20 to 20	
db2 Dead Band Zone 2	°F °C	3.6 2.0	0 to 36 0 to 20	
OPn2 Curtain Open On-Time	Seconds	3	0 to 254	
CLo2 Curtain Close On-Time	Seconds	5	0 to 254	
OFF2 Curtain Off Time	Seconds	140	0 to 254	
OF53 Set Point Zone 3	°F °C	0.0 0.0	-36 to 36 -20 to 20	
db3 Dead Band Zone 3	°F °C	3.6 2.0	0 to 36 0 to 20	
OPn3 Curtain Open On-Time	Seconds	3	0 to 254	
CLo3 Curtain Close On-Time	Seconds	5	0 to 254	
OFF3 Curtain Off Time	Seconds	140	0 to 254	
OF54 Set Point Zone 4	°F °C	0.0 0.0	-36 to 36 -20 to 20	
db4 Dead Band Zone 4	°F °C	3.6 2.0	0 to 36 0 to 20	
OPn4 Curtain Open On-Time	Seconds	3	0 to 254	
CLo4 Curtain Close On-Time	Seconds	5	0 to 254	
OFF4 Curtain Off Time	Seconds	140	0 to 254	
HER.1 Heat / Cool Offset	°F °C	0.0 0.0	-36 to 36 -20 to 20	
HER2 Heat / Cool Offset	°F °C	0.0 0.0	-36 to 36 -20 to 20	
RLH.1 High Temp. Alarm	°F °C	9.0 5.0	-36 to 0 -20 to 0	
RL.L0 Low Temp. Alarm	°F °C	-7.2 -4.0	-36 to 0 -20 to 0	

# Hidden Settings:

To view or modify Hidden Settings,

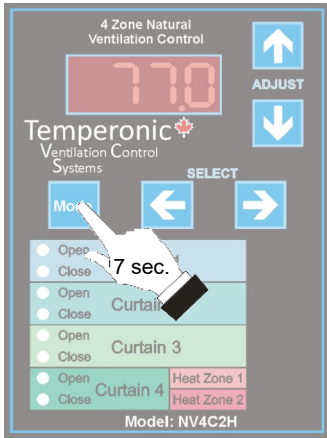

Press and hold the **Mode** Button until the display flashes **run** (about 7 seconds) then you are in the Hidden Settings Mode.

The **▲** arrow will increase Parameter values. The **▼** arrow will decrease Parameter values.

NOTE: Control will automatically return to the default display mode 2 minutes after the last button press.

Use the select arrows **◀** and **▶** to choose various parameters.

## **run** Heat Control System On / Off

Whenever the curtains are in-use, this setting must be set to “On”. When set to Off, all curtains will stay where they are (manual move still works). Heater Outputs will continue to function when Off to prevent the room from freezing.

## **dEGr** Temperature Units

This parameter allows selection of temperature units between °F and °C.

## **Pb.C 1 Pb.C.2 Pb.C 3** Probes to use for Curtain 1, 2 and 3

This control supports up to 4 indoor probes. This parameter allows selection of the probes to be averaged and used by Curtain zones 1, 2 or 3. Any combination of the 4 probes can be selected. Setting this parameter to ‘off’ will turn off the curtain and it will not move automatically.

## **Pb.C4** Probes to use for Curtain 4

This parameter selects the probes to use for Curtain 4 similar to the above setting. Note that Setting Pb.C4 to ‘Off’ enables heat stages to operate using the relays normally dedicated to operation of Curtain 4.

## **CLSt** Wind Sensor Close Timer

This parameter defines how long the curtains will run closed after wind is detected by the wind sensor. This is usually set to several seconds. The timer gets reset every time wind is detected by the sensor. When this Parameter is set to 0, the wind sensing function is disabled. If the control is not equipped with the optional wind sensor board, this parameter must be set to 0 for proper operation of the control.

## **nOPt Wind Sensor Open Delay Timer**

If the curtain closes due to wind, the temperature would normally cause the curtain to open again right away. To prevent this, an open delay timer prevents the curtains from opening for up to 254 minutes (4 hours). Normally, this value should be set to between 30 and 60 minutes. This timer is reset each time the wind sensors detect wind.

## **UU It Wind Sensor High Temperature Inhibit**

This parameter sets a temperature at which point the wind sensor is ignored. On very warm days, the curtain should remain open even if it is very windy. If the probe for a curtain is at or above the temperature specified here, the wind sensor will be ignored and the curtain will open normally even if the wind sensor is detecting wind. The separate Rain Sensor wired into the Rain Sensor Input can be used to over-ride the high temperature inhibit and cause the curtains to close when it's raining even if the room temperature is above the value in this parameter.

## **PbH.1 Heater 1 Probes to Average**

This parameter specifies the probes to use for the Zone 1 Heater.

## **PbH.2 Heater 2 Probes to Average**

This parameter specifies the probes to use for the Zone 2 Heater.

## **Hd IF Heater Differential**

When a heater turn on, it is important that it is allowed to run for a while before shutting off again. This parameter specifies how much the temperature in the room must climb before the heater shuts off. If a Heater is set up to turn on at 60°F and the heat differential is set to 0.7°F, then the heater will not shut off until the room temperature reaches 60.7°F.

## **[d IF Curtain Differential**

There may be unusual conditions where the temperature in the room changes rather quickly. Since the curtains operate on a timing cycle that may take over a minute to complete, the curtain differential can stop a curtain from moving open or closed when there is a rather sudden change in temperature. It works much the same as the heater differential. For example, if the Curtain Differential is set to 0.8°F and if the curtain starts to open at 77°F and the temperature in the room suddenly drops by 1.0°F while the actuator is running, the curtain will stop due to the fact the temperature dropped by a value greater than the curtain differential.

## **[dbd Curtain Differential Band**

When this parameter is set to 0, curtain movement skip is disabled. When set to 8.0, any time the temperature is within +/- 4.0 of the set point, the control will record the temperature the instant a curtain stops moving. The next time the curtain is set to move, the control compares the current temperature and the recorded temperature. If the difference is more than Cdif (in the desired direction), the control skips the schedule movement of the curtain.

## **dLY1 dLY2 Wind Delay Timers**

Strong winds can cause the wind sensor flapper on the leeward side of the building to activate, resulting in nearly all the curtains closed up to the wind sensors. These parameters help prevent that. To initiate closing due to wind, the flapper must be in the activated position for at least **dLY2** seconds out of a total sample time of **dLY1** seconds.

## **Automatic Curtain Adjustment**

The next 3 settings allow an automatic increase in the on-time when the room temperature is quite distant from the set point. There are times when the outdoor temperature can change quite suddenly and a slow moving curtain can take a long time to compensate for this sudden change. Then next 3 parameters can greatly speed up the response of a curtain to a sudden and significant change in temperature. Examine the parameters and the diagram and example on the following page to understand how these parameters work. These settings will affect the on and off times of both curtains in the same manner.

## **CCnA Curtain Timer Compensation No Adjust Band**

The value entered here indicates the temperature range above and below the Dead Band where the Curtain Open On-Time (Parameter **OPn.1**) and Curtain Close On-Time (Parameter **CLo.1**), follow the On-Times set in Parameters **OPn.1** and **CLo.1**. This parameter is disabled if parameters **CNOt** and **CCPb** are set to 0.

## **CNOt Maximum On-Time**

The value entered here indicates the Maximum On-Time that the curtain will use. If the Maximum On-Time entered here is greater than the [Open On-Time (Parameter **OPn.1**) + Off-Time (Parameter **OFF.1**)], or greater than the [Close On-Time (Parameter **CLo.1**) + Off-Time (Parameter **OFF.1**)], the controller will give the Off-Time a value of 5 seconds. Otherwise, the on time is increased and the off time is decreased as needed.

## **CCPb Timer Compensate Proportional Band**

The value entered here indicates the bandwidth over which the curtain goes from (Minimum On-Time, Maximum Off-Time) to (Maximum On-Time, Minimum Off Time).

For example:	Parameter <b>SEt.1</b> (Set Point)	70.0°F	
	Parameter <b>db.1</b> (Curtain Dead Band)		5.0°F
	Parameter <b>OPn.1</b> (Curtain Open On-Time)	60 sec.	
	Parameter <b>OFF.1</b> (Curtain Off-Time)	60 sec.	
	Parameter <b>CCnA</b> (Cur. Timer Comp. No Adjust Band)	1.0°F	
	Parameter <b>CNOt</b> (Max. On-Time)		90 sec.
	Parameter <b>CCPb</b> (Timer Comp. Prop. Band)	2.0°F	

Using example settings: When the Temperature in the room increases and reaches 72.5°F (Parameter Set.1 + 1/2 of Parameter db.1), the curtain starts to cycle Open for 60 sec. (Parameter OPn.1) Off for 60 sec. (Parameter Off.1). The curtain will continue to cycle Open 60 sec., Off 60 sec. for another 1.0°F increase in temperature (73.5°F), since this is the value set in Parameter CCnA (No adjust band setting). If the temperature continues to rise in the room (73.6°F to 75.5°F, 2.0°F bandwidth set in Parameter CCPb), the controller will gradually increase the Open On-Time and decrease the Off Time until the Max. Open On-Time is 90 sec. (Parameter CMOt). The Off time would be reduced to 30 seconds. These settings are only an example of how the controller is capable of lengthening the Open On-Time automatically as the temperature increases, to have the curtain in the fully open position quicker. The example shows the procedure which takes place on a temperature increase in the room. The same approach is taken when the temperature decreases in the room and the curtain closes.



# Diagram of Curtain Using Proportion Bandwidth operation.

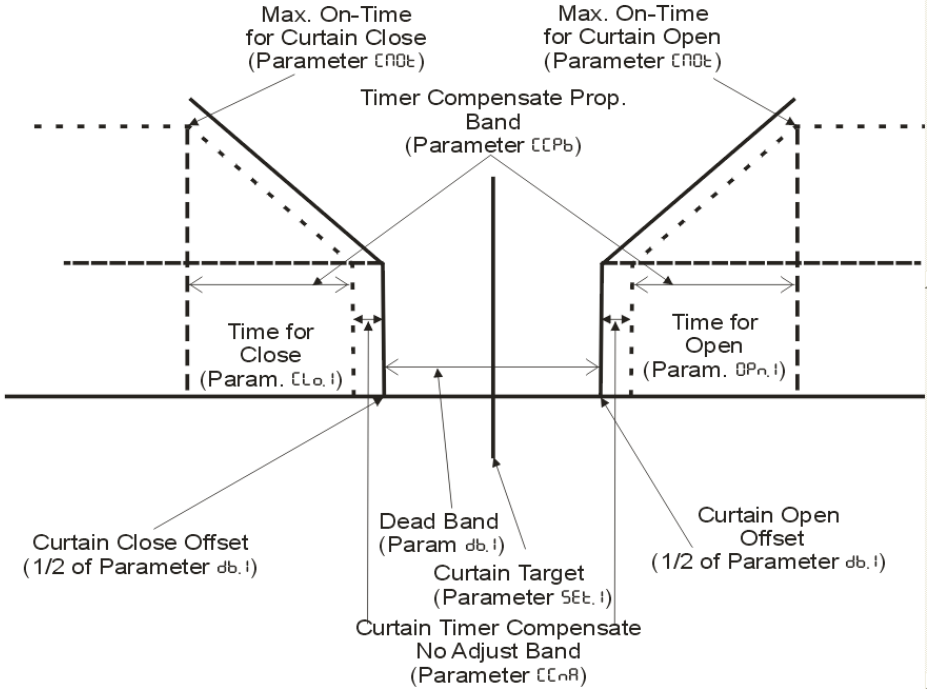

## Hidden Settings Table:

Setting	Units	Factory Default	Range	Record Your Settings
rUN Curtains On/Off		on	On / Off	
dE9r Temp. Units		°F	°F / °C	
Pb[1] Curtain 1 Probes to use.		1	off, 1 to 4	
Pb[2] Curtain 2 Probes to use.		2	off, 1 to 4	
Pb[3] Curtain 3 Probes to use.		3	off, 1 to 4	
Pb[4] Curtain 4 Probes to use.		4	off, 1 to 4	
CL5t Wind Sense Close Timer	Seconds	10	0 to 254	
nOPt Wind Open Delay Timer	Minutes	30	0 to 254	
UU It Wind High Temp Inhibit	°F °C	86.0 30.0	-40 to 99 -40 to 37.2	
PbH[1] Heat/Cool 1 Probes to use.		12	off, 1 to 4	
PbH[2] Heat/Cool 2 Probes to use.		34	off, 1 to 4	
Hd IF Heater Differential	°F °C	0.9 0.5	0 to 36 0 to 20	
Ed IF Curtain Differential	°F °C	0.9 0.5	0 to 36 0 to 20	
Edbd Curtain Differential Band	°F °C	0.9 0.5	0 to 36 0 to 20	
dLY1 Wind Delay Sample Time	Seconds	15.0	0 to 25.4	
dLY2 Wind Delay Trigger Time	Seconds	2.0	0 to 25.4	
ELnR Curtain No Adjust Band	°F °C	0.9 0.5	0 to 36 0 to 20	
ENOt Curtain Max On-Time	Seconds	25	0 to 254	
ELbP Curtain Adj. Prop. Band	°F °C	3.6 2.0	0 to 36 0 to 20	
SELU Security Status		Off	On/Off	

# Control Mounting Instructions

Mount to a flat, inside wall.

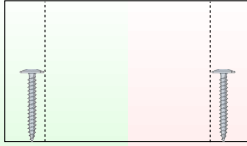

Don't Mount to an uneven wall. It will cause the box to warp and it will not seal well.  
Don't Mount on an outside wall, the cool temperature can cause water to form inside the enclosure.

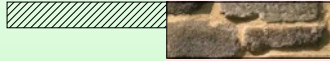

Leave at least 10" of space on the heat-sink side of the control.

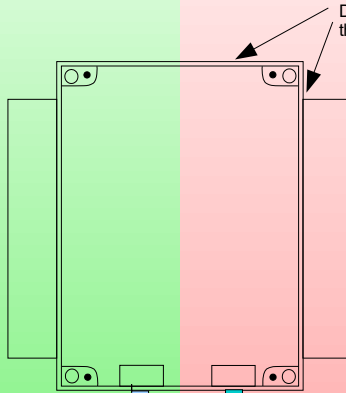

All Wiring Enters the Bottom of the Enclosure

Use Shielded cable for probes and potentiometer

Cross High Voltage Wires at 90°

High Voltage Wiring

Don't run low voltage wires next to high voltage wires.  
Don't cross at an angle other than 90°

Do

Don't

# NV4C2H WIRING DIAGRAM

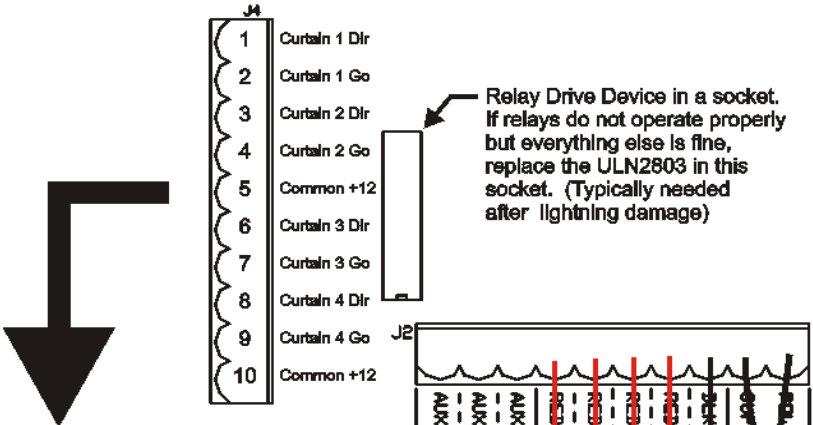

Wiring to relays on next page.

## Alarm Contacts

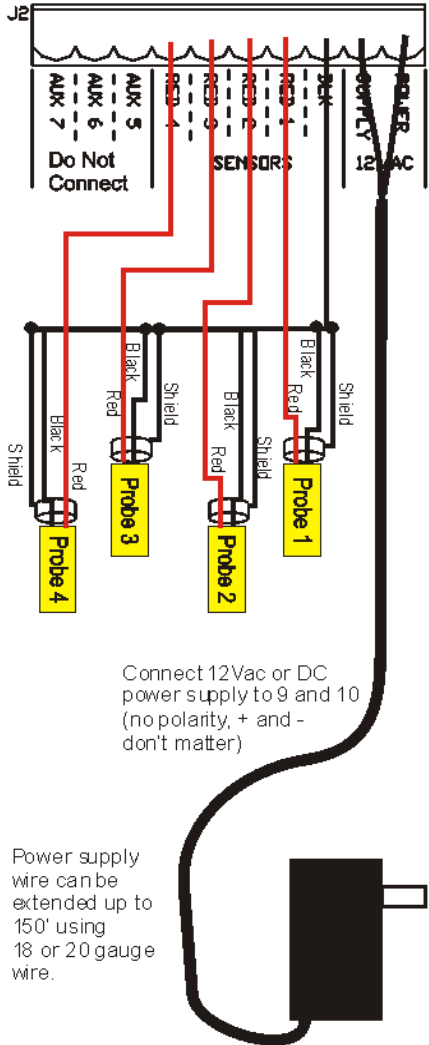
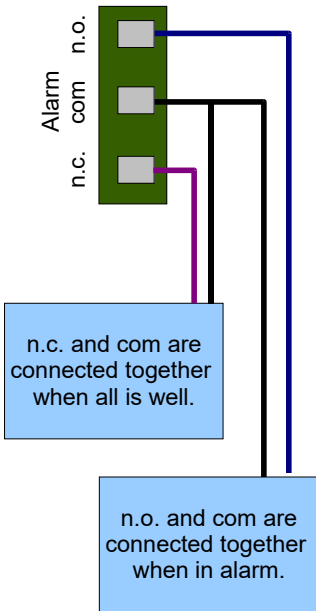

Connect 12Vac or DC power supply to 9 and 10 (no polarity, + and - don't matter)

Power supply wire can be extended up to 150' using 18 or 20 gauge wire.

12 Volt Power Supply

# Wind Sensor Wiring Instructions:



Curtain 1 wind sensor

Mount the wind sensor inside the room on the stud wall near the top of the curtain with the metal flapper towards the curtain. Adjust the height of the sensor on the wall to establish a minimum curtain opening even during windy conditions.

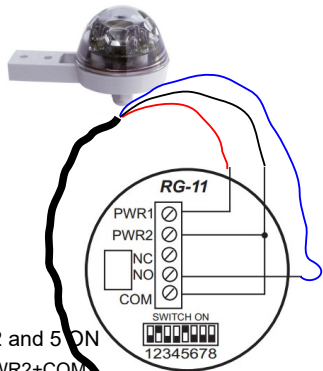

Switches 2 and 5 ON

GND BLK to PWR2+COM

RAIN BLUE to N.O.

+12 RED to PWR1

Rain sensor will disable **UU it**

Rain Sensor  
PWR2 and COM  
to GND  
PWR1 to +12  
NO to Wind 3

Blue Wire to GND  
Black to Wind  
Brown to +12V

Wind Sensor Connector on top of board

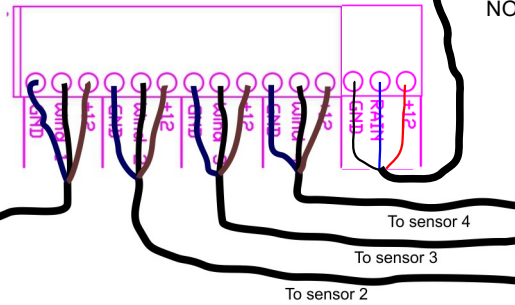

The connector on the top of the board is a spring connector. To connect the wire, press down green tab and insert the wire end into the hole. Release the green tab. The wire will be secured in place. To remove the wire, press down on the green tab to release the wire. While holding down the tap pull the wire out. **Do not** place more than one wire a hole on the spring connectors.

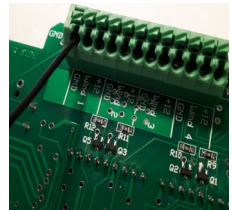
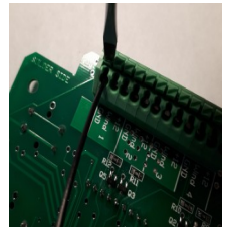

Model NV4C2H-F has the wind sensor connections built in. Sensors on Curtains 2 to 4 are connected in the same manner as Sensor 1 shown here.

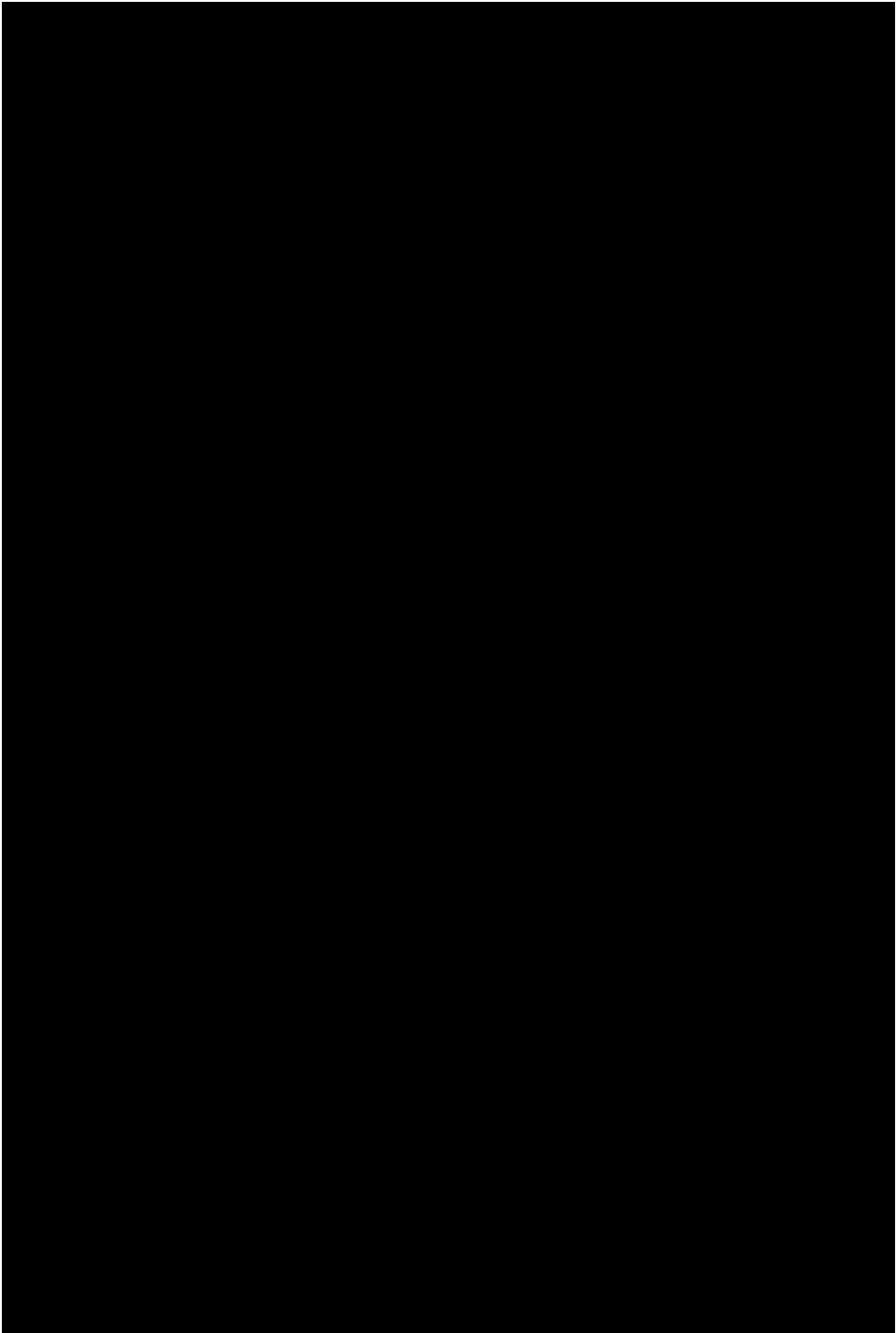

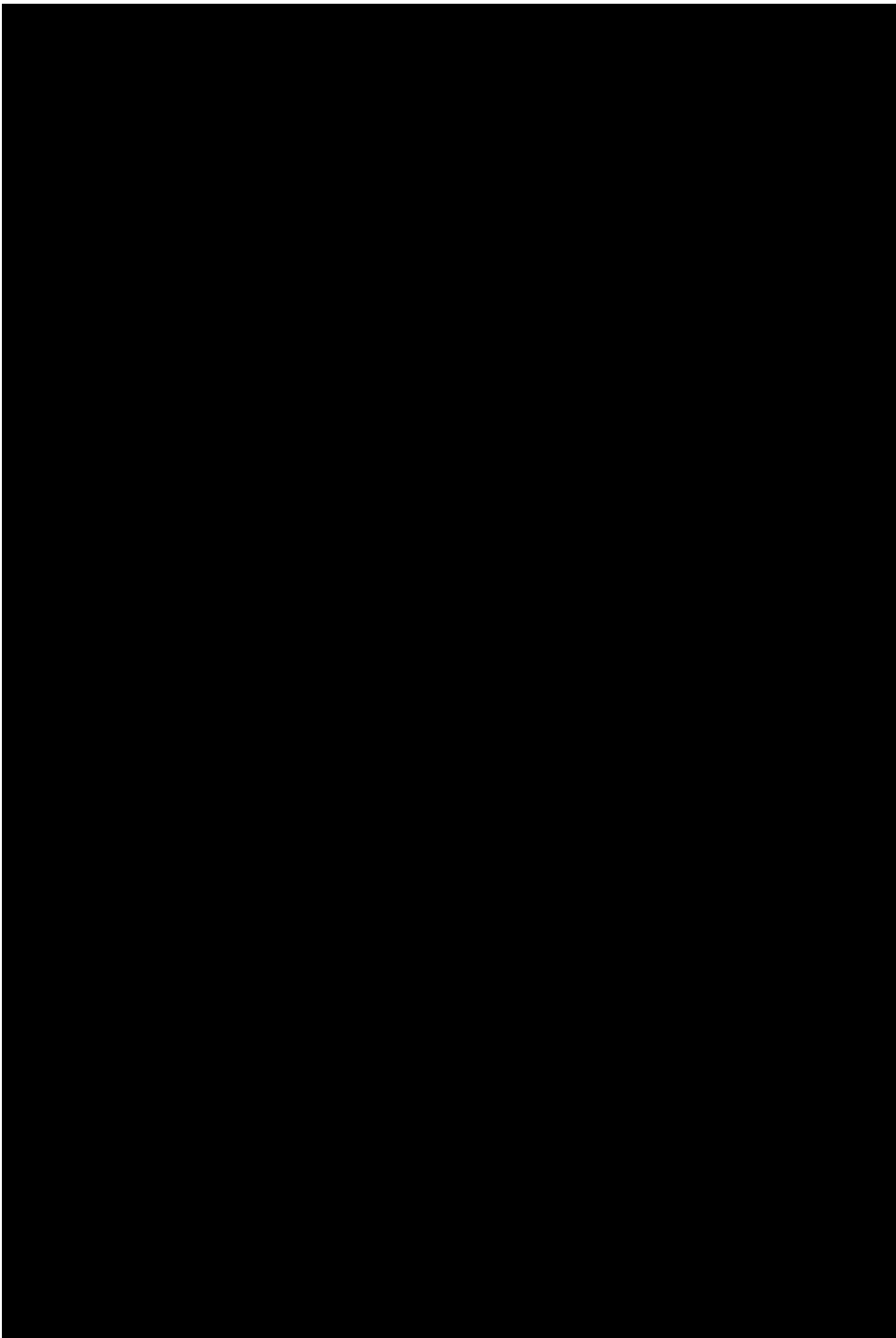

## **Limited Warranty**

Veldhuis Digital Engineering Ltd. hereby warrants that should this unit prove defective, Veldhuis Digital Engineering Ltd. will repair the unit free of charge but subject to the following conditions and a time period of 1 year at 100% coverage of parts and labour to repair or replace the unit as determined by Veldhuis Digital Engineering Ltd.. Veldhuis Digital Engineering Ltd. assumes no responsibility for losses resulting directly or indirectly from the use of this control unit beyond the replacement or repair of the control unit.

1. The unit must have been installed in accordance with the installation instructions contained in this manual, such that the contents of the control are protected from moisture and dust using liquid tight connections on all wiring into the control housing. Any holes cut into top or side of control enclosure void warranty of controller.
2. No modification of the control has been done by anyone other than qualified Veldhuis Digital Engineering Ltd. personnel.
3. The control unit must not have been subject to abuse, misuse or accident or operated other than as specified in this manual. Any decision on this condition by Veldhuis Digital Engineering Ltd. will be final.
4. Warranty will only be provided to the original purchaser of this product and proof of purchase must be provided at the time of a warranty request. Warranty period begins at date of manufacture as found on the control unit unless date of sale and serial numbers are clearly indicated on proof of purchase documents.
5. This warranty is only applicable to control unit NV4C2H
6. All shipping charges are the responsibility of the purchaser.
7. For best warranty service, return a defective control unit to your local dealer along with proof of purchase of the unit.

**DISCLAIMER: EXCEPT AS PROHIBITED BY APPLICABLE LAW, AND EXCEPT AS SPECIFIED ABOVE, VELDHUIS DIGITAL ENGINEERING LTD. MAKES NO WARRANTIES OR REPRESENTATIONS, EXPRESS OR IMPLIED, ORAL OR WRITTEN, REGARDING THE CONTROL UNIT OR DOCUMENTATION AND HEREBY EXPRESSLY DISCLAIMS ALL OTHER EXPRESS AND IMPLIED WARRANTIES, INCLUDING THE IMPLIED WARRANTIES OF MERCHANTABILITY AND FITNESS FOR A PARTICULAR PURPOSE. VELDHUIS DIGITAL ENGINEERING LTD. DOES NOT WARRANT THE UNIT WILL MEET YOUR REQUIREMENTS OR THAT ITS OPERATION WILL BE UNINTERRUPTED OR ERROR FREE.**